

KOMPAKTNI CILINDRI / COMPACT CYLINDERS

KOMPAKTNI CILINDER ADM, ASM, ASMZ / COMPACT CYLINDER ADM, ASM, ASMZ

Tehnični podatki / Technical data

Medij Fluid	filtriran, suh ali naoljen komprimiran zrak filtered, dry or oiled compressed air
Delovni tlak Working pressure	max. 10 bar
Temperatura Temperature	+80 °C

Material	
Pokrovi / End caps	Aluminij / Aluminium
Cev / Tube	Aluminij / Aluminium
Batnica / Rod	X 20 Cr 13
Vodilna puša / Guide	bronza / bronze
Tesnila / Seals	PU



ADM



ASM



ASMZ



i ŠTEVILO UTOROV ZA SENZORJE / NUMBER OF SLOTS FOR SENSORS
Ø16, Ø40: 3 UTORI / SLOTS
Ø50, Ø100: 7 UTOROV / SLOTS
Senzorji stran 38 / Sensors page 38

i Vsi ADM, ASM, ASMZ cilindri so opremljeni z magnetom na batni v PU obroči v končnih legah. Mazanje pri filtriranem in sušenem zraku ni potrebno!
All ADM, ASM, ASMZ cylinders are equipped with magnet on the piston and PU rings at the end positions. Lubricating is not necessary, when filtered, dry air is used!

i Senzorji stran 38
Sensors page 38

PRIMER NAROČANJA / HOW TO ORDER

Tip cilindra / Type of cylinder

- **ADM:** ...dvostransko delujoč cilinder / double acting cylinder
- **ASM:** ...enostransko delujoč cilinder s povratno vzmetjo
single acting cylinder with return spring
- **ASMZ:** ...enostransko delujoč cilinder z vzmetjo
single acting cylinder with spring

Nazivni premer / Diameter

16, 20, 25, 32, 40, 50, 63, 80, 100

Hod / Stroke

- **ASM** ...max. 40 mm
- **ASMZ** ...max. 40 mm

□ - □ - □ - □ - PA - □ - □

Dodatna opcija / Additional option

- **E:** ...podaljšana batnica / extended rod

Opcija / Option

- **/:** ...standard / standard
- **S2:** ...skožnja batnica / through rod

Posebna izvedba / Special version

- **/:** ...standard / standard
- **A:** ...zunanji navoj na batnici
male thread on the rod

Priporočeni maks. hod / Adviced max. stroke

	Ø16	Ø20	Ø32	Ø40	Ø50	Ø63	Ø80	Ø100
ADM	40	50	50	80	80	80	80	80

**ADM, ASM, ASMZ
Ø32 – Ø100**

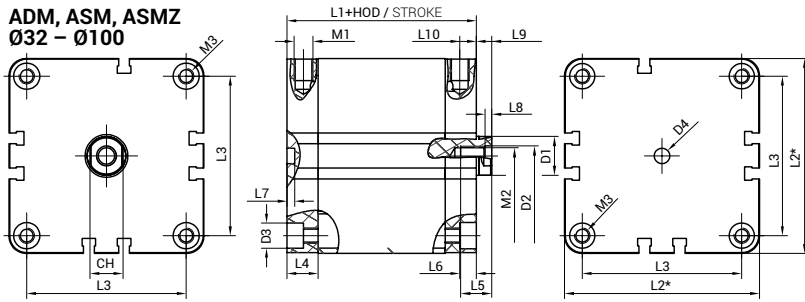

Posebna izvedba A / Special version A:

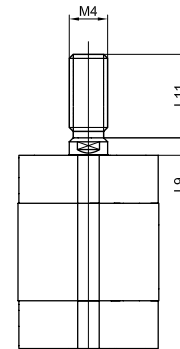

**ADM, ASM, ASMZ
Ø16 – Ø25**

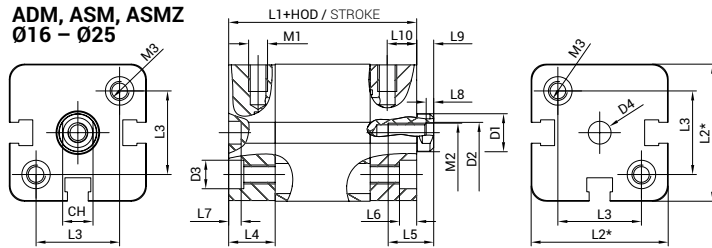

Ø	L1	L2*	L3	L4	L5	L6	L7	L8	L9	L10	L11	ØD1	ØD2	ØD3	ØD4	M1	M2	M3	M4	CH	Teža Weight 1*	Teža Weight 2*
16	38	29	18	12,25	8	3,5	4	1,5	4,5	8	20	8	4,25	6	6	M5	M4	M4	M8	6	0,09	0,01
20	38	36	22	12,25	10	4,5	4	2	4,5	8	22	10	5,25	7,5	6	M5	M5	M5	M10x1,25	8	0,13	0,02
25	39,5	40	26	12,75	10	4,5	4	2	5,5	8	22	10	5,25	7,5	6	M5	M5	M5	M10x1,25	8	0,15	0,03
32	44,5	50	32	14,5	12	5,5	4	2,5	6	8	22	12	6,25	9	6	G1/8	M6	M6	M10x1,25	10	0,27	0,04
40	45,5	58	42	14,75	12	5,5	4	2,5	6,5	8	22	12	6,25	9	6	G1/8	M6	M6	M10x1,25	10	0,38	0,05
50	45,5	67	50	14,75	12	6,5	4	3	7,5	8	24	16	8,25	10,5	6	G1/8	M8	M8	M12x1,25	13	0,50	0,06
63	50	80	62	14,25	14	8,5	4	3	7,5	8	24	16	8,25	13,5	8	G1/8	M8	M10	M12x1,25	13	0,77	0,07
80	56	100	82	16	15	8,5	4	3,5	8	8,5	32	20	10,25	13,5	8	G1/8	M10	M10	M16x1,5	17	1,42	0,11
100	66,5	124	103	19,25	20	8,5	4	3,5	10	10,5	40	25	12,25	13,5	8	G1/4	M12	M10	M20x1,5	22	2,55	0,17

L2*	Zunanja mera cevi Tube's outer dimension	1* Teža Weight	Teža [kg] (hod = 0 mm) Weight [kg] (stroke = 0mm)	2* Teža Weight	Teža [kg] vsakih 10 mm Weight [kg] per every 10mm
-----	---	-------------------	--	-------------------	--

Pritrditve za cilindre ADM, ASM, ASMZ, ADMA / Accessories for cylinders ADM, ASM, ASMZ, ADMA

ASU

Ø16-Ø25

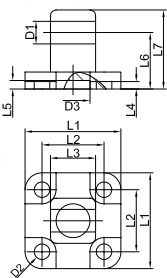

Ø32-Ø100

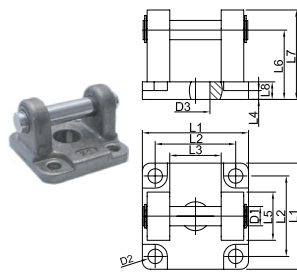

Ø	L1	L2	L3	L4	L5	L6	L7	L8	ØD1	ØD2	ØD3	m [kg]
16	27	18	12	2,6	3	16	22	6	6	4,5	10	0,02
20	34	22	16	2,6	3	20	28	6	8	5,5	12	0,02
25	38	26	16	2,6	3	20	28	6	8	5,5	12	0,03
32	48	32	26	5,5	20	22	32	9	10	6,6	14	0,06
40	58	42	28	5,5	25	25	37,5	9	12	6,6	14	0,10
50	66	50	32	6,5	25	27	39,5	11	12	9	18	0,14
63	83	62	40	6,5	30	32	47	11	16	9	18	0,24
80	102	82	50	10	30	36	51	13	16	11	23	0,42
100	123	103	60	10	40	41	61	13	20	11	28	0,72

AFL

Ø16-Ø25

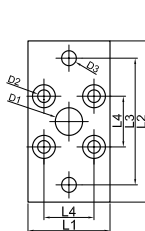

Ø32-Ø100

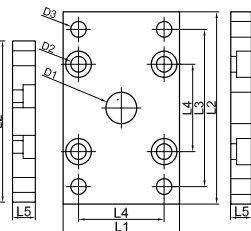

Ø	L1	L2	L3	L4	L5	ØD1	ØD2	ØD3	m [kg]
16	29	55	43	18	10	10	4,5	5,5	0,01
20	36	70	55	22	10	12	5,5	6,6	0,02
25	40	76	60	26	10	12	5,5	6,6	0,02
32	50	80	65	32	10	14	6,6	7	0,26
40	60	102	82	42	10	14	6,6	9	0,42
50	68	110	90	50	12	18	9	9	0,60
63	87	130	110	62	15	18	9	9	1,20
80	107	160	135	82	15	23	11	12	1,80
100	128	190	163	103	15	28	11	14	2,55

AHP

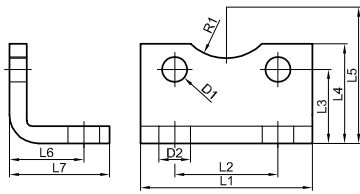

i Set vsebuje 2 kosa
Set contains 2 pcs

Ø	L1	L2	L3	L4	L5	L6	L7	ØD1	ØD2	R1	m [kg]
16	30	18	13	17,5	24	13	17,5	4,4	5,5	9	0,02
20	36	22	16	22	26	16	22	5,4	6,6	10	0,03
25	40	26	17	23	28	16	22	5,4	6,6	11	0,04
32	50	32	16	24	29	18	26	6,6	6,6	12	0,07
40	60	42	21,5	29,5	-	20	28	6,6	9	-	0,10
50	68	50	22	30	-	24	32	9	9	-	0,15
63	84	62	28,5	39	-	27	39	9	11	-	0,25
80	102	82	24,5	36,5	-	30	42	11	11	-	0,38
100	123	103	26,5	38,5	-	33	45	11	13,5	-	0,50

SG

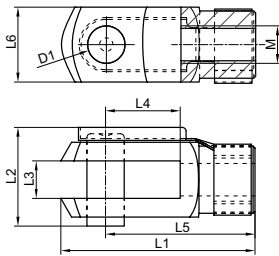

Tip Type	M	L1	L2	L3	L4	L5	L6	ØD1	m [kg]
SGM 4	M4	21	11	4	8	16	8	4	0,01
SGM 6	M6	31	16	6	12	24	12	6	0,02
SGM 8	M8	42	21,5	8	16	32	16	8	0,05
SGM 10	M10	52	26	10	20	40	20	10	0,09
SGM 10x1,25	M10x1,25	52	26	10	20	40	20	10	0,09
SGM 12x1,25	M12x1,25	62	32	12	24	48	24	12	0,12
SGM 16x1,5	M16x1,5	83	39	16	32	64	32	16	0,33
SGM 20x1,5	M20x1,5	105	53	20	40	80	40	20	0,70

FK

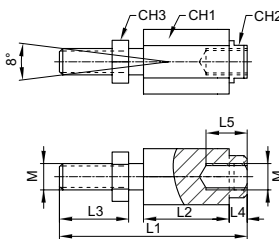

Tip Type	M	L1	L2	L3	L4	L5	CH1	CH2	CH3	m [kg]
FKM 4	M4	33	16,5	8	4,5	12,5	11	11	7	0,02
FKM 6	M6	35	17,5	11	3,5	12,5	13	7	10	0,03
FKM 8	M8	57	26	21	5	16	17	10	13	0,06
FKM 10	M10	71,5	35	18	8	23	30	19	17	0,22
FKM 10x1,25	M10x1,25	71,5	35	20	9	23	30	19	17	0,22
FKM 12x1,25	M12x1,25	74,5	35	24	9	23	30	19	19	0,23
FKM 16x1,5	M16x1,5	104	53	32	9	32	41	27	24	0,66
FKM 20x1,5	M20x1,5	119	53	40	16	39	41	27	30	0,70

SGS

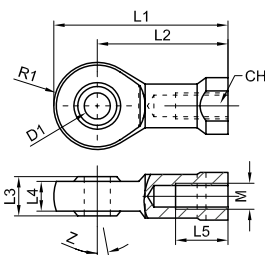

Tip Type	M	L1	L2	L3	L4	L5	ØD1	R1	CH	Z°	m [kg]
SGSM 4	M4	36	27	8	6	10	5	9	9	13	0,02
SGSM 6	M6	40	30	9	6,8	12	6	10	11	13	0,03
SGSM 8	M8	48	36	12	9	16	8	12	14	13	0,05
SGSM 10	M10	57	43	14	10,5	20	10	14	17	13	0,08
SGSM 10x1,25	M10x1,25	57	43	14	10,5	20	10	14	17	13	0,08
SGSM 12x1,25	M12x1,25	66	50	16	12	22	12	16	19	13	0,11
SGSM 16x1,5	M16x1,5	85	64	21	15	28	16	21	22	15	0,22
SGSM 20x1,5	M20x1,5	102	77	25	18	33	20	25	30	14	0,41